



CLEARPOINT®
THE WINNING COMBINATION
FOR CLEAN COMPRESSED AIR

COST SAVINGS BASED ON ENERGY COST REDUCTION



THE BIGGEST POTENTIAL FOR SAVINGS IS IN THE REDUCTION OF YOUR ENERGY AND MAINTENANCE COSTS.

Compressed air filtration is assessed to various criteria, such as type, quality, reliability and technical efficiency of compressed air filters. All this must add up to economical efficiency: With compressed air systems working to more or less at full capacity, 80% of the running costs is due to energy consumption.

And right here, the new CLEARPOINT® compressed air filters will help you save money.

The energy costs are significantly influenced by the pressure drop during compressed air filtration. In order to maintain the required operating pressure, the compressor performance has to be stepped up to compensate for the pressure drop. The consequence: higher energy consumption, increased compressor wear...resulting in higher running costs. The better solution: CLEARPOINT® compressed air filters from BEKO.

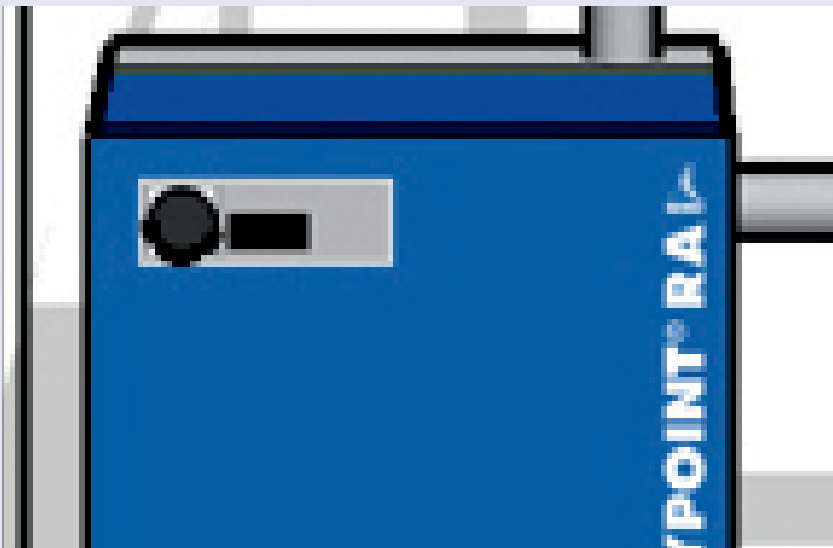

For stationary and mobile applications from industry to medical:

CLEARPOINT® filters are your guarantee for economic and top quality compressed air filtration.

Filter and drain must perform their duty in unity, otherwise condensate could be carried over, which lowers the quality of the treated compressed air and causes poor results at the down-stream compressed air points of use.



QUALITY DOUBLED

The condensate drain plays an important role in ensuring optimum filtration. What is the use of a high class filter, if the drain attached to the filter gives poor performance or is simply not suited for the job? In order to prevent this, CLEARPOINT® filters are equipped with the best condensate drain available: The electronically level controlled BEKOMAT®.

In addition to the well known reliable functions of a BEKOMAT®, this unit was developed especially for the use with filters and offers additional advantages:

- Integrated monitoring of the useful lifetime of the filter element to automatically indicate the optimal time of element change
- Easily readable, informative display
- Potential free contact for relaying a fault signal to a control center
- Condensate discharge at the rear through elbow connector, ideal for installation close to a wall

+1: **LOW, OPTIMIZED OPERATING COSTS**

+2: **RELIABLE REMOVAL OF LIQUIDS (SUCH AS WATER OR OIL), DUST, GASES OR AEROSOLS**

+3: **LONGER FILTER SERVICE LIFE AND COMPRESSOR LIFE CYCLE**

+4: **REDUCED MAINTENANCE, INCREASED PRODUCTIVITY**

+5: **BETTER SERVICE AND WORKING CONDITIONS**

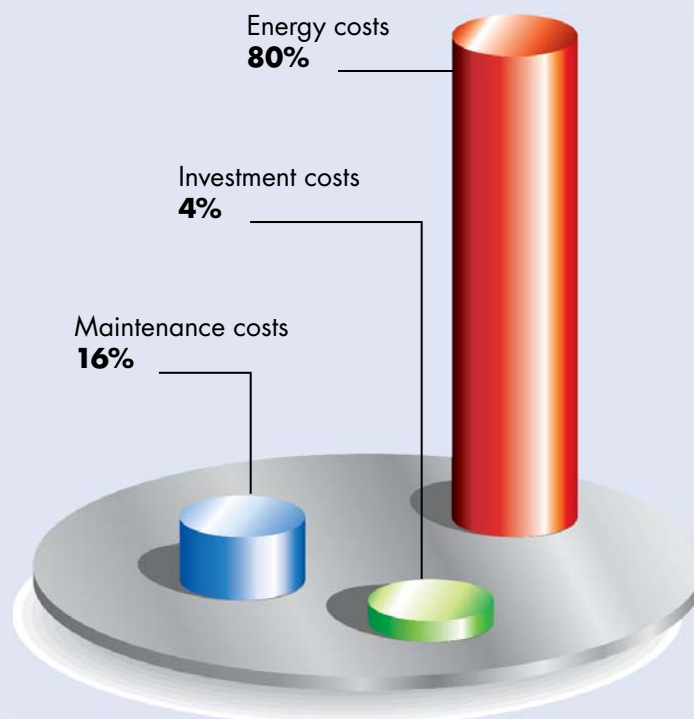

AN INNOVATIVE CONCEPT...

1 The threaded connections of the CLEARPOINT® compressed air filters are oversized in comparison to other filters on the market. They are specially matched to the typical pipe diameters of various compressed air equipment, thus eliminating energy consuming pipe reductions. When combining two or more CLEARPOINT® filters, the innovative connection maintains the full diameter flow.

3 CLEARPOINT® filter elements are installed without tie-rods so that the cross-sectional area is fully available. This reduces the flow resistance, while the space required for element replacement is only about one third compared with other designs – a great advantage under spatially restricted conditions. Thanks to the innovative push-fit design of the filter elements, replacement is very fast and simple. The element is held securely in a leak tight position by an O-ring seal at the top cap and three supports at the bottom of the housing.



4 With an extremely high void volume of 96%, the bor silicate filter material ensures that the pressure loss is kept to a minimum. Conventional filter material of sintered polyethylene only has a void volume of 45%. With CLEARPOINT® filters, the cross-sectional area available for flow is therefore more than twice as large. Compared to other filter elements, the material of CLEARPOINT® filter elements is impregnated as a standard. This prevents swelling up of the filter material, permits a steady differential pressure, and avoids unnecessary expenditure.

5 Condensate from compressed-air filtration is nearly always aggressive, so that un-protected housings would be exposed to corrosion. CLEARPOINT® filter housings are made of seawater-resistant aluminum and are additionally anodized inside. This offers increased corrosion protection, while the permanently smooth surface also reduces the flow resistance.

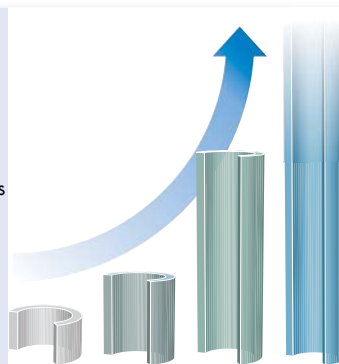

Standard aluminum (left) compared to the anodized, sea water resistant aluminum in BEKO housings (right).



...CONVINCING IN DETAIL

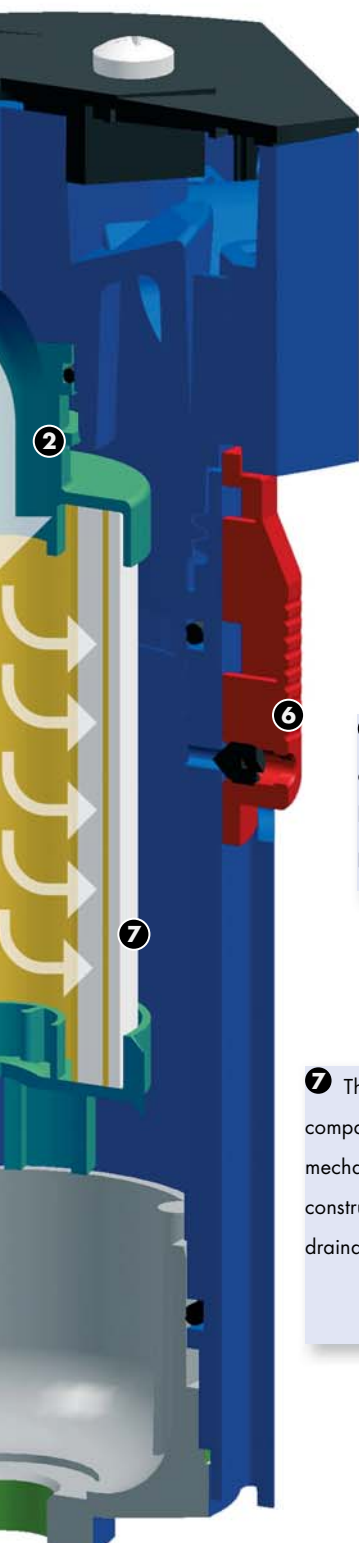

2 FLOW RESISTANCE OF A PIPE BEND
at same pipe length

Connection		3/8"	1/2"	3/4"
Bend, R=d		0.2	0.3	0.3
Angle, 90°		0.8	1.0	1.2

6 The closing mechanism is a safety feature that allows 100% control during opening of the filter housing. If the housing is opened while still under pressure, an audible warning signal will be given.



7 The standard needlefelt drainage layer has a high thermostability (up to 248 °F) compared with the foamed plastic used in other filter products. It is also chemically and mechanically highly resistant and free of silicone. Combined with the reliable construction, the filter element is absolutely safe against an expansion or damage to the drainage layer. A continual use of the whole filter surface is thus realized.

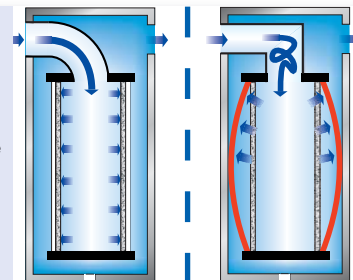

TECHNICAL DATA

CLEARPOINT®

WATER SEPARATORS

Filter Model	Connection IN-OUT	Flow Rate scfm	Number of filter elements	A	B	C2	D	Volume gal	Weight lbs
S040	3/8"	24	-	2.95	1.10	7.09	5.91	0.07	0.55
S050	1/2"	45	-	2.95	1.10	8.27	5.91	0.08	1.87
S075	3/4"	105	-	3.94	1.34	11.02	5.91	0.23	3.75
M010	1"	140	-	3.94	1.34	13.78	5.91	0.30	4.63
M015	1"	220	-	5.75	1.89	14.37	6.30	0.67	9.04
M020	1 1/2"	410	-	146	37	365.5	160	0.90	11.24
M022	1 1/2"	530	-	146	37	418.5	160	1.12	13.45
M025	2 1/2"	880	-	10.24	3.03	26.42	7.87	3.67	43.87
M030	3"	1325	-	10.24	3.03	35.24	7.87	5.15	57.10

COALESCING FILTERS

Filter Model	Connection IN-OUT	Flow Rate scfm	Number of filter elements	A	B	C2	D	Volume gal	Weight lbs
S040	3/8"	24	1	2.95	1.10	7.09	5.91	0.07	0.55
S050	1/2"	45	1	2.95	1.10	8.27	5.91	0.08	1.87
S055	1/2"	70	1	2.95	1.10	10.43	5.91	0.11	2.65
S075	3/4"	105	1	3.94	1.34	11.02	5.91	0.23	3.75
M010	1"	140	1	3.94	1.34	13.78	5.91	0.30	4.63
M012	1"	170	1	3.94	1.34	15.16	5.91	0.33	4.85
M015	1 1/2"	220	1	5.75	1.89	14.37	6.30	0.67	9.04
M018	1 1/2"	290	1	5.75	1.89	16.46	6.30	0.78	9.92
M020	2"	410	1	5.75	1.89	18.43	6.30	0.90	11.24
M022	2"	530	1	5.75	1.89	22.24	6.30	1.12	13.45
M023	2"	690	1	5.75	1.89	26.89	6.30	1.38	15.65
M025	2 1/2"	880	1	10.24	3.03	26.42	7.87	3.67	43.87
M027	2 1/2"	1100	1	10.24	3.03	30.51	7.87	4.36	49.82
M030	3"	1325	1	10.24	3.03	35.24	7.87	5.15	57.10
M032	3"	1625	1	10.24	3.03	41.14	7.87	6.14	65.92

SPECIFICATION OF FILTER ELEMENTS:

- Corrosion resistant end caps
- Stainless steel support sleeve
- Coarse fleece
- 6 layers of filter media
- Coarse drainage layer
- 2 stainless steel support sleeves
- Fine needlefelt drainage layer
- High chemical and thermal resistance

Max. oil carryover	25 µm Class 5	15 µm Class 4	5 µm Class 3	1 µm Class 2	0.1 µm Class 1	Particle filtration
0.01 mg/m ³ Class 1						A S
0.1 mg/m ³ Class 2				C		
1 mg/m ³ Class 3						
5 mg/m ³ Class 4				C		
25 mg/m ³ Class 5	C					

FILTRATION GRADE

- C = Coarse filter
- G = General purpose filter
- F = Fine filter
- S = Super fine filter
- A = Activated carbon filter

TECHNICAL DATA

CLEARPOINT® PN

Filter Model	Connection IN-OUT	Flow Rate scfm	Number of Filter Elements	A	B	C2	D	Volume gal	Weight lbs	Maximum Pressure Rating psig
S040	3/8"	24	1	2.95	1.10	7.09	5.91	0.07	0.55	725
S050	1/2"	45	1	2.95	1.10	8.27	5.91	0.08	1.87	725
S075	3/4"	105	1	3.94	1.34	11.02	5.91	0.23	3.75	725
M010	1"	140	1	3.94	1.34	13.78	5.91	0.30	4.63	725
M015	1 1/2"	220	1	5.75	1.89	14.37	6.30	0.67	9.04	725
M020	2"	410	1	5.75	1.89	18.43	6.30	0.90	11.24	725

Filter Model	Connection IN-OUT	Flow Rate scfm	Number of filter elements	A	B	C2	D	Volume gal	Weight lbs	Maximum Pressure Rating psig
S040	3/8"	24	1	2.95	1.10	7.09	5.91	0.07	0.55	725
S050	1/2"	45	1	2.95	1.10	8.27	5.91	0.08	1.87	725
S055	1/2"	70	1	2.95	1.10	10.43	5.91	0.11	2.65	725
S075	3/4"	105	1	3.94	1.34	11.02	5.91	0.23	3.75	725
M010	1"	140	1	3.94	1.34	13.78	5.91	0.30	4.63	725
M012	1"	170	1	3.94	1.34	15.16	5.91	0.33	4.85	725
M015	1 1/2"	220	1	5.75	1.89	14.37	6.30	0.67	9.04	725
M018	1 1/2"	290	1	5.75	1.89	16.46	6.30	0.78	9.92	725
M020	2"	410	1	5.75	1.89	18.43	6.30	0.90	11.24	725

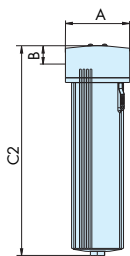

Operating pressure bar	0.3	0.6	1	2	3	4	5	6	7	8	9	10	11	12	13	14	15	16
Correction factor	0.21	0.29	0.38	0.53	0.65	0.76	0.84	0.92	1	1.07	1.13	1.19	1.25	1.31	1.36	1.41	1.46	1.51

HIGH QUALITY COMPRESSED AIR FROM BEKO

The quality of your compressed air.

RELIABLE

The highest level of operational reliability is guaranteed with every product that BEKO manufactures.

EFFICIENT

Maximum energy efficiency and conservation are guiding principles of every product design.

ECONOMIC

Products that provide the quickest return on investment in the industry with the least amount of risk.

EFFECTIVE

German engineered with no compromises on quality.

EXPERIENCE

More than 25 years of industry leading experience stands behind our entire product offering.

SOLUTIONS

Your single source for a range of performance compressed air products designed to work in synergy.

*Compressed air treatment and condensate technology.
The complete program. Worldwide.*

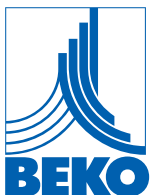

BEKO TECHNOLOGIES CORP

900 Great Southwest Parkway SW Phone +1 (800) 235-6797
Atlanta, GA 30306 Fax +1 (404) 629-6666
USA beko@bekousa.com

www.bekousa.com

